

Varenummer: 20955461
 Beskrivelse: E+G Justerfod
 GN 342.1-40-M12-SV

Mål

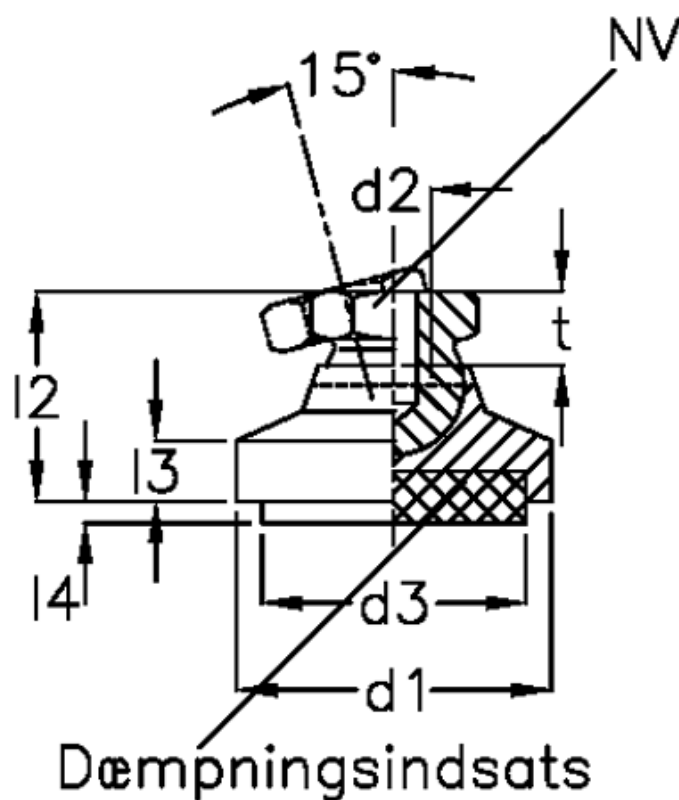

Area(m2) damping insert	= 1134	l4 compression 0,6 N/mm2	= 3.9
d1	= 40	Load (N) by compression 0,4 N/mm2	= 450
d2	= M12	t	= 11.5
d3	= 38		
l2	= 30.0		
l3	= 9.5		
l4 compression 0 N/mm2	= 6.0		
l4 compression 0,4 N/mm2	= 4.8		